

GALT-2V-5 Pocket Door System (Overlay)



| Item Name | GALT-2V-5S-16~28 S Type (2 Rails) | GALT-2V-5M16~28 M Type (3 Rails) | GALT-2V-5L-16~28 L Type (3 Rails) | GALT-2V-5LL-16~28 LL Type (4 Rails) |
|----------------|---|--|---|---|
| Door Width | Max. 560 mm | Max. 560 mm | Max. 560 mm | Max. 600 mm |
| Door Height | 830~1060 mm | 1250~1500 mm | 1650~1840 mm | 1990~2300 mm |
| Door Thickness | Max. 20 mm | | | |
| Door Weight | Max. 5 kg | Max. 6 kg | Max. 8 kg | Max. 10 kg |

Features

- Opening door is stored inside the cabinet
- 5 mm overlay coverage in side board
- One touch door installation & removal

Note

- For wooden door only

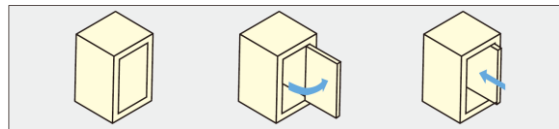
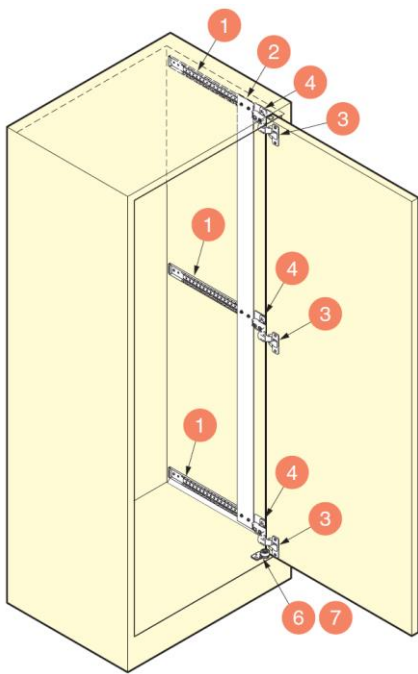

Door Cut Out Dimensions

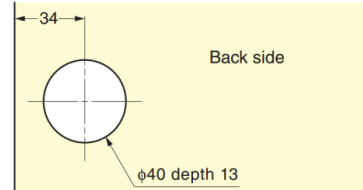

Installation

Rail Installation & Clearance Dimensions

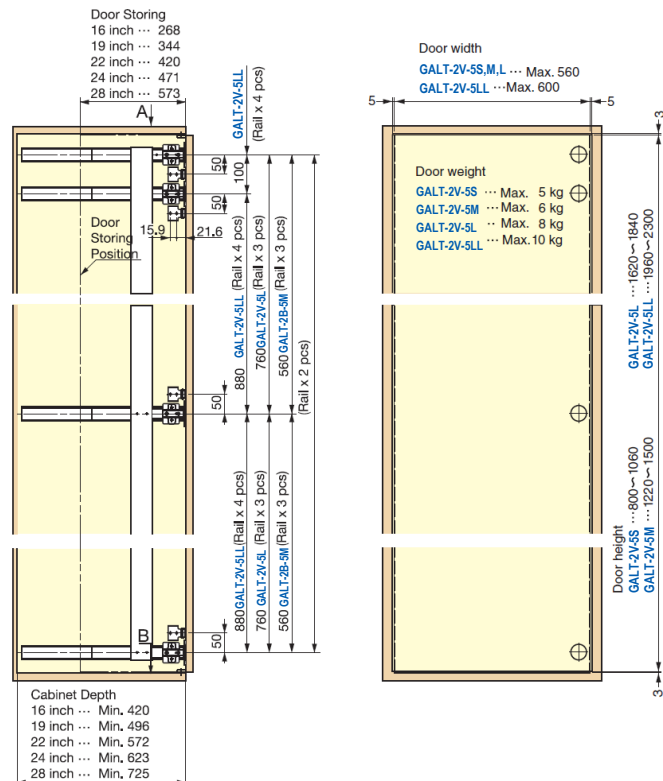
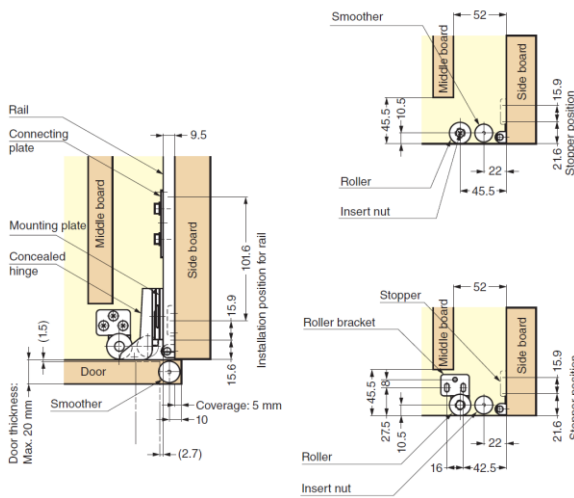



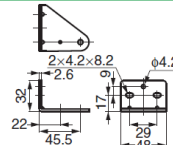

| Parts Set (Per Door) | | Necessary Parts | | | | | | | | | |
|----------------------|----------------|-----------------|-------|--------------------|------|--------------------------|-------|------------------|-------|----------------|-------|
| Type | Part No. | Part Name | | | | | | | | | |
| | | 1 Rail | | 2 Connecting Plate | | 3 Concealed Hinge (Body) | | 4 Mounting Plate | | 5~11 Parts Set | |
| | | Item Name | Qty | Item Name | Qty | Item Name | Qty | Item Name | Qty | Item Name | Qty |
| S | GALT-2V-5S-16 | GAL127C-16 | 2 pcs | GALT55-S | 1 pc | G51-MH45-05-15 | 2 pcs | G520401 M5020 | 2 pcs | GALT-2V-5SP | 1 set |
| | GALT-2V-5S-19 | GAL127C-19 | 2 pcs | | 1 pc | | 2 pcs | | 2 pcs | | 1 set |
| | GALT-2V-5S-22 | GAL127C-22 | 2 pcs | | 1 pc | | 2 pcs | | 2 pcs | | 1 set |
| | GALT-2V-5S-24 | GAL127C-24 | 2 pcs | | 1 pc | | 2 pcs | | 2 pcs | | 1 set |
| | GALT-2V-5S-28 | GAL127C-28 | 2 pcs | | 1 pc | | 2 pcs | | 2 pcs | | 1 set |
| M | GALT-2V-5M-16 | GAL127C-16 | 3 pcs | GALT55-M | 1 pc | G51-MH45-05-15 | 3 pcs | G520401 M5020 | 3 pcs | GALT-2V-5MP | 1 set |
| | GALT-2V-5M-19 | GAL127C-19 | 3 pcs | | 1 pc | | 3 pcs | | 3 pcs | | 1 set |
| | GALT-2V-5M-22 | GAL127C-22 | 3 pcs | | 1 pc | | 3 pcs | | 3 pcs | | 1 set |
| | GALT-2V-5M-24 | GAL127C-24 | 3 pcs | | 1 pc | | 3 pcs | | 3 pcs | | 1 set |
| | GALT-2V-5M-28 | GAL127C-28 | 3 pcs | | 1 pc | | 3 pcs | | 3 pcs | | 1 set |
| L | GALT-2V-5L-16 | GAL127C-16 | 3 pcs | GALT55-L | 1 pc | G51-MH45-05-15 | 3 pcs | G520401 M5020 | 3 pcs | GALT-2V-5LP | 1 set |
| | GALT-2V-5L-19 | GAL127C-19 | 3 pcs | | 1 pc | | 3 pcs | | 3 pcs | | 1 set |
| | GALT-2V-5L-22 | GAL127C-22 | 3 pcs | | 1 pc | | 3 pcs | | 3 pcs | | 1 set |
| | GALT-2V-5L-24 | GAL127C-24 | 3 pcs | | 1 pc | | 3 pcs | | 3 pcs | | 1 set |
| | GALT-2V-5L-28 | GAL127C-28 | 3 pcs | | 1 pc | | 3 pcs | | 3 pcs | | 1 set |
| LL | GALT-2V-5LL-16 | GAL127C-16 | 4 pcs | GALT55-LL | 1 pc | G51-MH45-05-15 | 4 pcs | G520401 M5020 | 4 pcs | GALT-2V-5LLP | 1 set |
| | GALT-2V-5LL-19 | GAL127C-19 | 4 pcs | | 1 pc | | 4 pcs | | 4 pcs | | 1 set |
| | GALT-2V-5LL-22 | GAL127C-22 | 4 pcs | | 1 pc | | 4 pcs | | 4 pcs | | 1 set |
| | GALT-2V-5LL-24 | GAL127C-24 | 4 pcs | | 1 pc | | 4 pcs | | 4 pcs | | 1 set |
| | GALT-2V-5LL-28 | GAL127C-28 | 4 pcs | | 1 pc | | 4 pcs | | 4 pcs | | 1 set |

Optional Parts

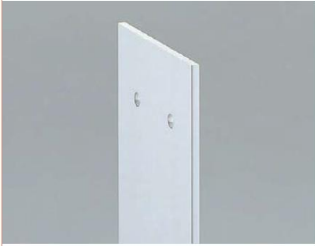
| No. | Installation Position | Qty | Part No. | Part Name | Dimensions | Description |
|-----|------------------------------|------|-------------|---|---|---|
| 12 | For Lower Right & Upper Left | 1 pc | GALT-2V5BR1 | Side Mount Bracket  |  | <ul style="list-style-type: none"> Material: Steel Finish: Yellow Zinc Chromate |
| 13 | For Upper Right & Lower Left | 1 pc | GALT-2V5BR2 | | | |

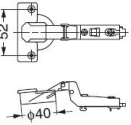
GALT-2V-5 Parts Set Details

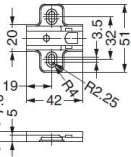
| No. | Qty | | | | Part Name | Dimensions | Description |
|-----|-------|-------|-------|-------|--|--|---|
| | S | M | L | LL | | | |
| 1 | 2 pcs | 3 pcs | 3 pcs | 4 pcs | Rail  | See Rail Dimensions. | GAL127C-16 GAL127C-19 GAL127C-22 GAL127C-24 GAL127C-28 <ul style="list-style-type: none"> ● Material Steel ● Finish Clear Zinc Chromate |
| 2 | 1 pc | 1 pc | 1 pc | 1 pc | Connecting Plate  | See Connecting Plate Dimensions. | GALT55-S GALT55-M GALT55-L GALT55-LL <ul style="list-style-type: none"> ● Material Aluminium Alloy ● Finish Plain |
| 3 | 2 pcs | 3 pcs | 3 pcs | 4 pcs | Concealed Hinge (Body)  |  | G51-MH45-05-15 <ul style="list-style-type: none"> ● Material Steel ● Finish Nickel w/ Catch |
| 4 | 2 pcs | 3 pcs | 3 pcs | 4 pcs | Mounting Plate  |  | G520401M5020 <ul style="list-style-type: none"> ● Material Steel ● Finish Nickel |

Rail Dimensions

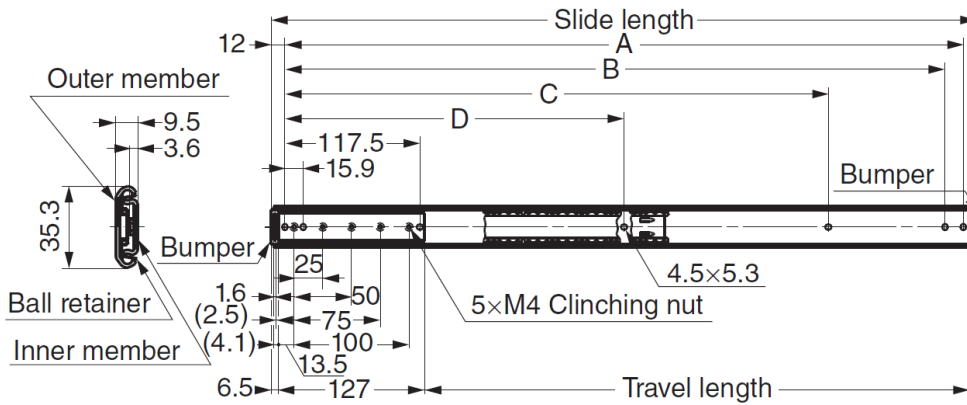

| Part No. | Slide Length | Travel Length | Door Storage | A | B | C | D |
|------------|--------------|---------------|--------------|-------|-------|-------|-------|
| GAL127C-16 | 411.4 | 269.4 | 268 | 387.4 | 371.5 | 269.9 | - |
| GAL127C-19 | 487.6 | 345.6 | 344 | 463.6 | 447.7 | 346.1 | 231.8 |
| GAL127C-22 | 563.8 | 421.8 | 420 | 539.8 | 523.9 | 422.3 | 269.9 |
| GAL127C-24 | 614.6 | 472.6 | 471 | 590.6 | 574.7 | 473.1 | 295.3 |
| GAL127C-28 | 716.2 | 574.2 | 573 | 692.2 | 676.3 | 574.7 | 346.1 |

Connecting Plate Dimensions

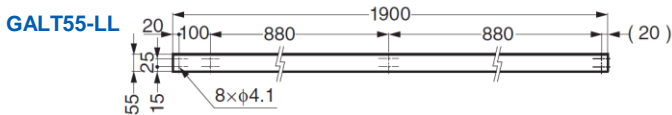
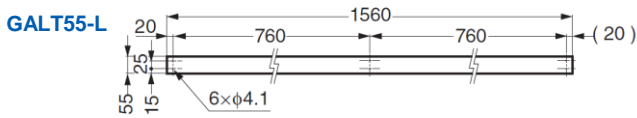
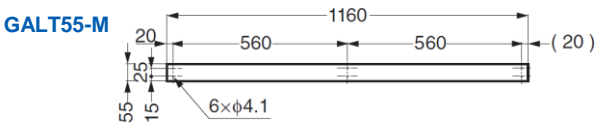
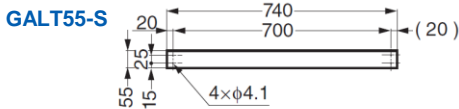

Parts Set Details

- | | | | |
|----------|--------------------|----------|---------------------|
| a | GALT-2V-5SP | c | GALT-2V-5LP |
| b | GALT-2V-5MP | d | GALT-2V-5LLP |

| No. | Qty | | | | Part Name | Dimensions | Description |
|-----|-------------------------|-------------------------|-------------------------|-------------------------|---|---|---|
| | a | b | c | d | | | |
| 5 | 1 pc | 2 pcs | 2 pcs | 2 pcs |  |  | GAL127-CH <ul style="list-style-type: none"> Material PUR Finish Black |
| 6 | 2 pcs | 2 pcs | 2 pcs | 2 pcs |  |  | GDU19-B4SBR <ul style="list-style-type: none"> Material EPDM / Steel Finish Clear Zinc Chromate / White |
| 7 | 1 pair (Left and Right) | 1 pair (Left and Right) | 1 pair (Left and Right) | 1 pair (Left and Right) |  |  <p>Letter stamped indicates type (shown).</p> | GALT-2V-AB GALT-2V-BB <ul style="list-style-type: none"> Material Steel Finish Yellow Zinc Chromate |
| 8 | 2 pcs | 2 pcs | 2 pcs | 2 pcs |  |  | GSC-107-13 <ul style="list-style-type: none"> Material PA Finish White |
| 9 | 2 pcs | 2 pcs | 2 pcs | 2 pcs |  |  | GG-175 <ul style="list-style-type: none"> Material PE Finish Natural |
| 10 | 2 pcs | 3 pcs | 3 pcs | 4 pcs |  |  | GALT-2V5P <ul style="list-style-type: none"> Material Steel Finish Yellow Zinc Chromate |
| 11 | 2 pcs | 3 pcs | 3 pcs | 4 pcs |  |  | GALT-AD <ul style="list-style-type: none"> Material UR / Steel Finish Clear Zinc Chromate / White |

Parts Included

- Hex key, pan head screw M4×6, binding head tapping screw, countersunk head tapping screw, hexagon top bolt M4×6, countersunk head screw M4×6

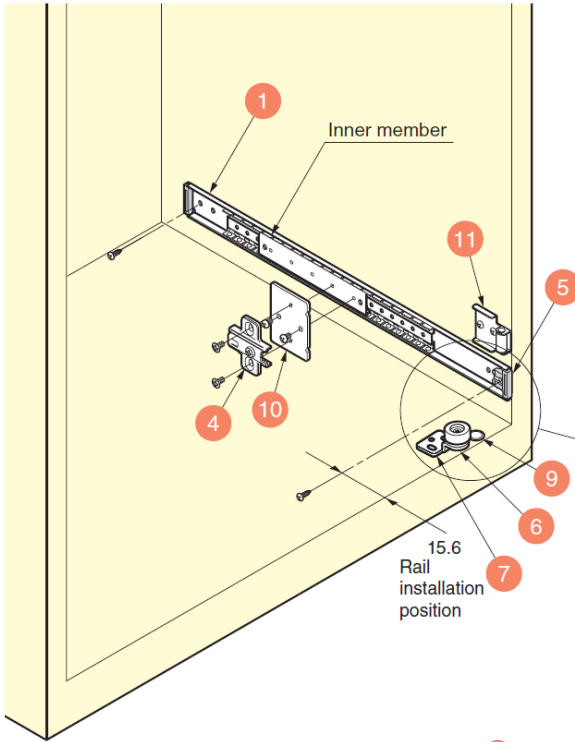

Temporary Installation of Rail 1

- Fix 11.
- Fix 1 with 5.
- Fix 10 and 4 onto Inner member of 1.
- Attach 5 to 1 as per the drawing on the right.

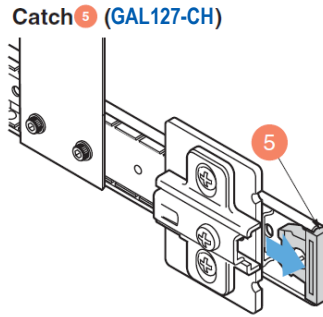

Installation of Catch 5

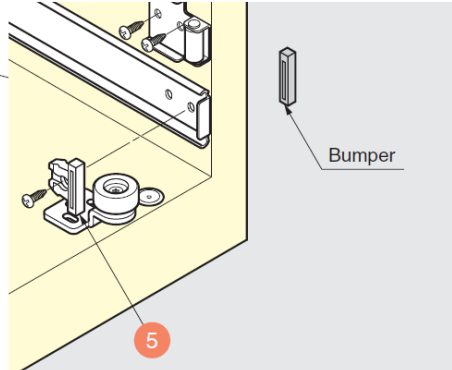

Remove the bumpers from the lower two rails, and replace with the catches 5. If the number of rail is two (S type), replace on the lower rail only.

Installation of Bracket 12 13

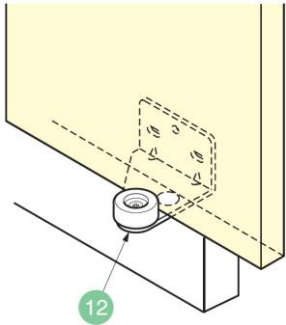

Installation Dimensions of Bracket 12 13

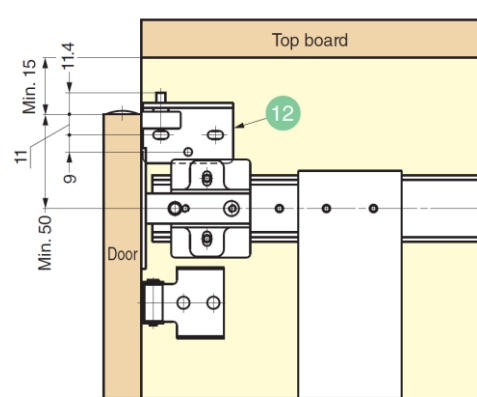

Installation of Slider 9

[Section C-C]

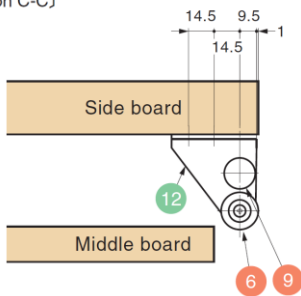

Right side installation

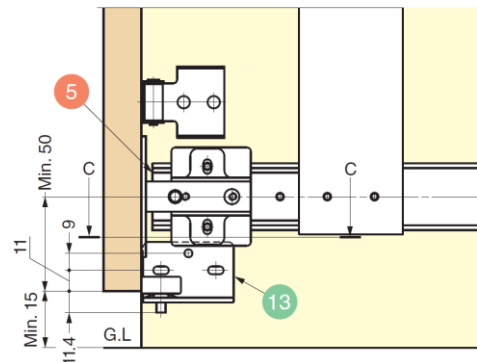

Installation of Connecting Plate 2

- Mount the connecting plate on the rails temporarily
- Make sure that the connecting plate moves smoothly
- Tighten the screws of the connecting plate

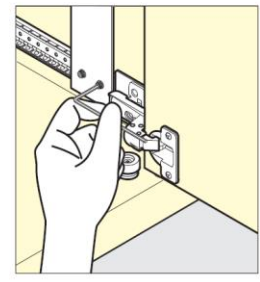
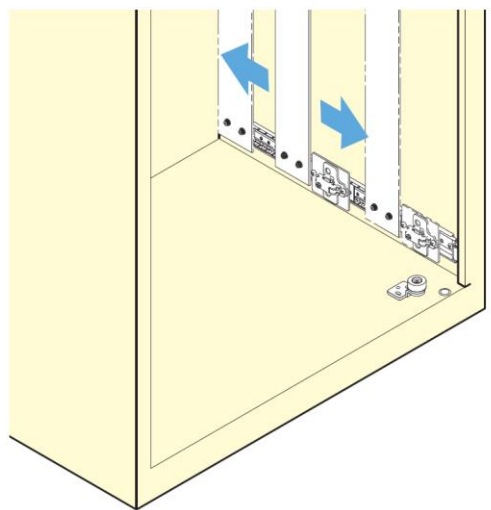

Hanging Door

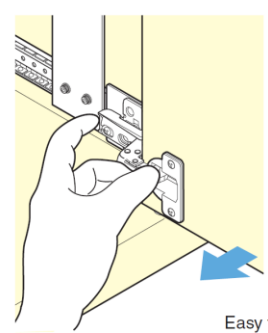
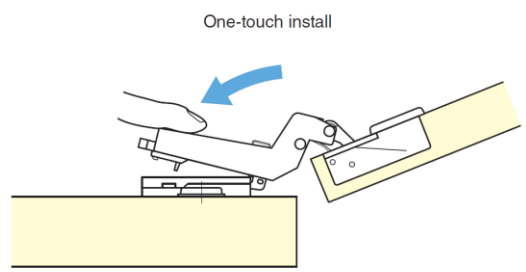

Door Adjustment

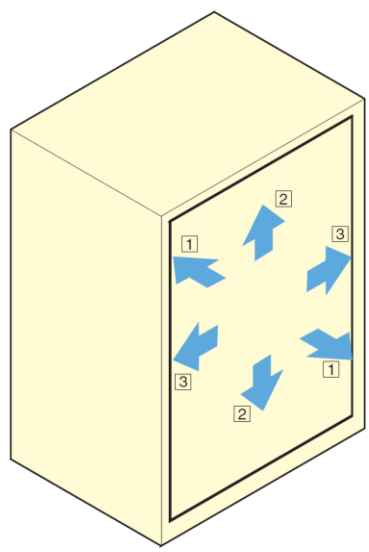

- 1 Front/Back adjustment
- 2 Height adjustment
- 3 Left/Right adjustment

